

## 8/16 kN HKPV Manual Toggle Press

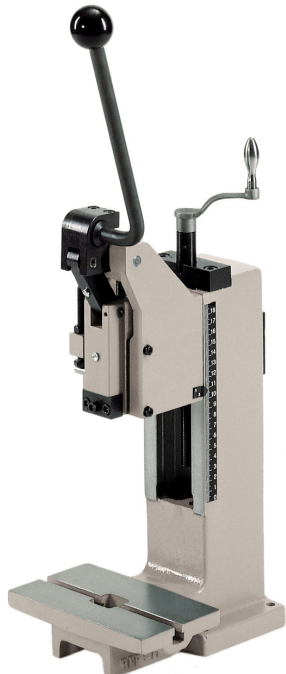

The BalTec 8/16kN HKPV press is a robustly designed small press with lots of features.

- The handle can be changed for left hand use or right hand use and can be positioned in any orientation
- The ram is vee guided to ensure the ram does not rotate during use and also ensures accurate guidance
- The front spigot clamping block gives accurate all round clamping
- A return lock mechanism can be fitted. A return lock mechanism will allow the press to return only when the complete stroke has been completed
- Large table with Tee slot clamping surface
- Quick and easy head height adjustment
- Also available as head only
- DXF, DWG and 3D Model files available on request

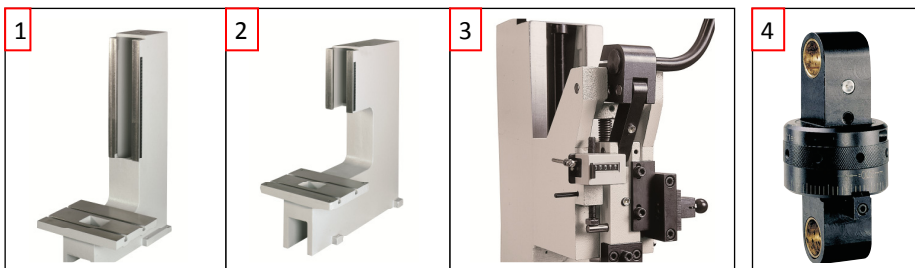

### Accessories

1. Extra height frame
2. Extra throat depth frame
3. Return Lock Mechanism and Counter
4. Fine Adjustment

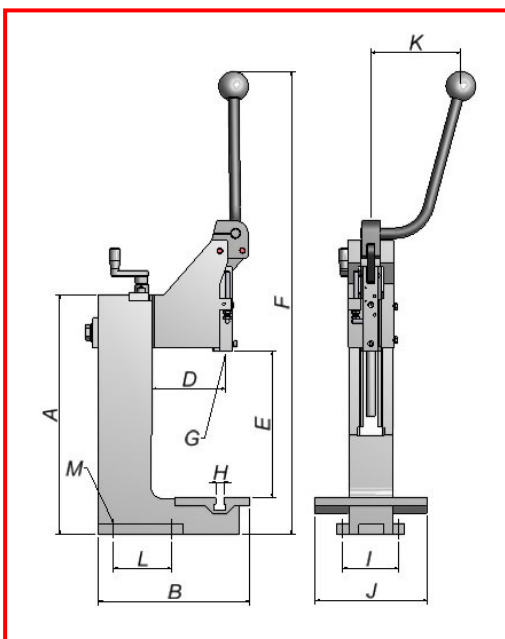

Dimensions	8/16 kN HKPV
A	590
B	420
C	15
D	160
E	100 - 320
F	930 - 1150
G	Ø15 H7
H	10
I	144
J	300
K	160
L	130
M	Ø9
Stroke	0 - 58
Force at lower position	Max 32kN
Weight	79kg