

8 kN HKP/L Hand Aided Pneumatic Press

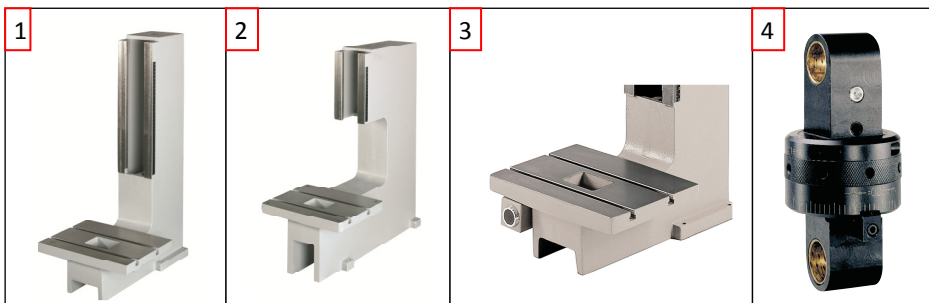

The BalTec 8kN HKP/L press is a robustly designed small press with lots of features.

- The ram is vee guided to ensure the ram does not rotate during use and also ensures accurate guidance
- The handle can be positioned anywhere over 360° for operator comfort
- The front spigot clamping block gives accurate all round clamping
- When the operator closes the toggle of the press the pneumatic cylinder will operate to complete the press stroke given 5.8mm of power stroke
- Large table with Tee slot clamping surface
- Quick and easy head height adjustment
- Also available as head only
- DXF, DWG and 3D Model files available on request
- Complies with CE standards without any additional guarding



Accessories

1. Extra height frame
2. Extra throat depth frame
3. Additional Start Button
4. Fine Adjustment

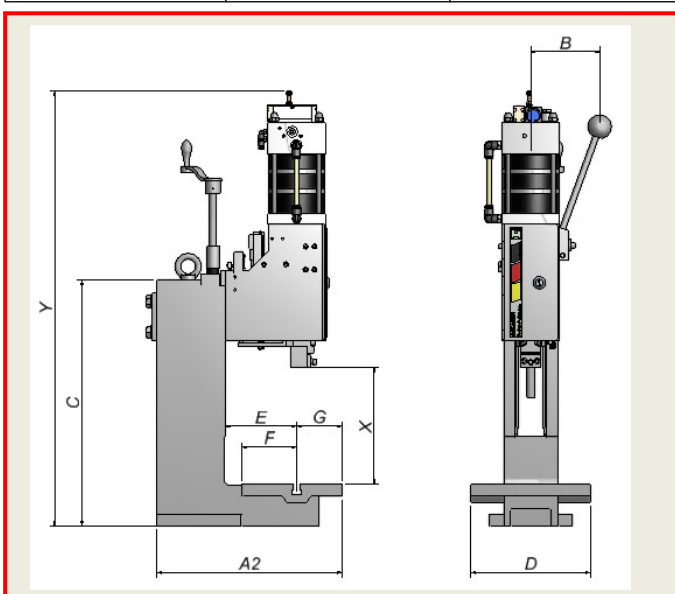

Dimensions	8 kN HKP/L
A2	340
B	110
C	415
D	200
E	120
F	92
G	75
U	21
X	73 - 240
Y	529 - 697
Ram Location Dia	Ø10 H7
Stroke	0-46
Force at lower position	Max 8kN @7 bar