

56 kN LP Straight Acting Pneumatic Press

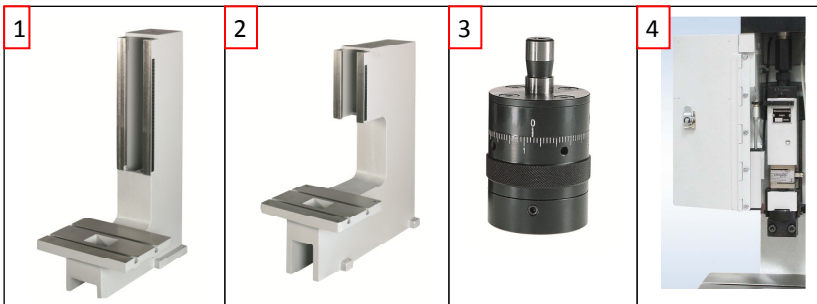

The BalTec 56kN LP press is a robustly designed small press with lots of features.

- The ram is vee guided to ensure the ram does not rotate during use and also ensures accurate guidance
- The front spigot clamping block gives accurate all round clamping
- Large table with Tee slot clamping surface
- Quick and easy head height adjustment
- Also available as head only
- There are 3 stroke options available, 40mm , 60mm , 80mm
- DXF, DWG and 3D Model files available on request
- Complies with CE standards without any additional guarding
- Comes with a variety of control features. Please see separate control sheet for more details



Accessories

1. Extra height frame
2. Extra throat depth frame
3. Fine Adjustment
4. Force monitoring options

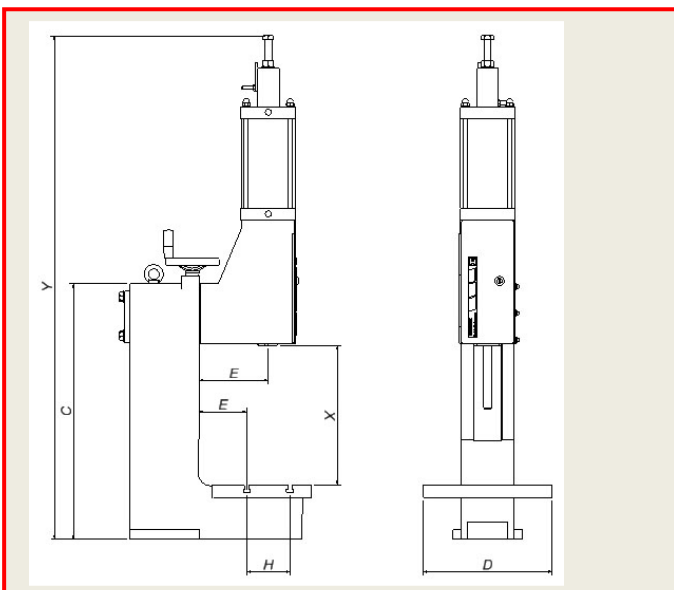

Dimensions	56 kN LP
C	715
D	340
E	200
F	150
G	120
H	100
U	49
X	115 - 370
Y	1135 - 1390
Ram Location Dia	Ø25 H7
Stroke	0 – 40mm
	0 – 60mm
	0 – 80mm
Force at lower position	Max 45kN @6 bar