

## 45 kN LP Straight Acting Pneumatic Press

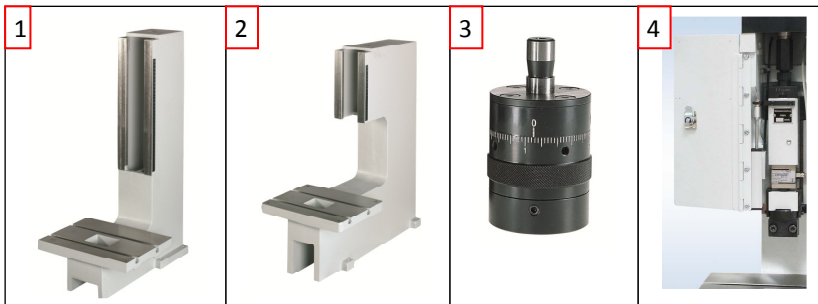

The BalTec 45kN LP press is a robustly designed small press with lots of features.

- The ram is vee guided to ensure the ram does not rotate during use and also ensures accurate guidance
- The front spigot clamping block gives accurate all round clamping
- Large table with Tee slot clamping surface
- Quick and easy head height adjustment
- Also available as head only
- There are 3 stroke options available, 40mm , 60mm , 80mm
- DXF, DWG and 3D Model files available on request
- Complies with CE standards without any additional guarding
- Comes with a variety of control features. Please see separate control sheet for more details



### Accessories

1. Extra height frame
2. Extra throat depth frame
3. Fine Adjustment
4. Force monitoring options

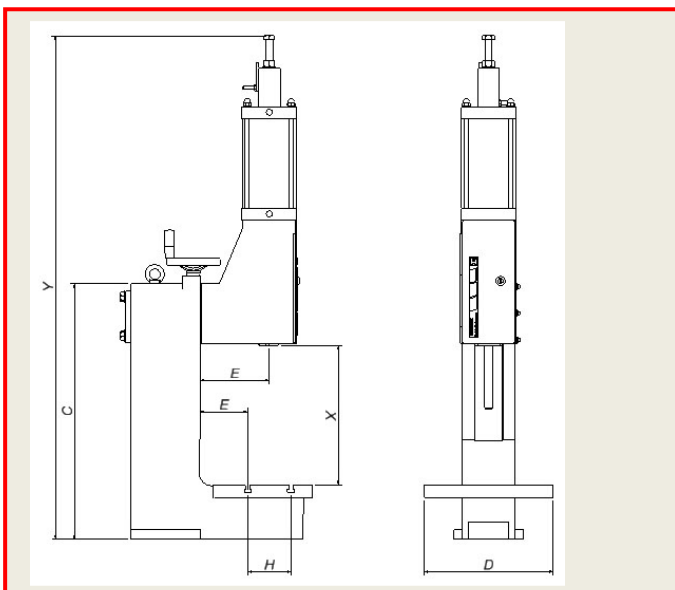

Dimensions	33 kN LP
C	715
D	340
E	200
F	150
G	120
H	100
U	49
X	115 - 370
Y	1135 - 1390
Ram Location Dia	Ø25 H7
Stroke	0 – 40mm
	0 – 60mm
	0 – 80mm
Force at lower position	Max 45kN @6 bar